

Article number: 20476667

Description: E+G Tommy screw with movable bar
DIN 6306M 10-50-E

Measures

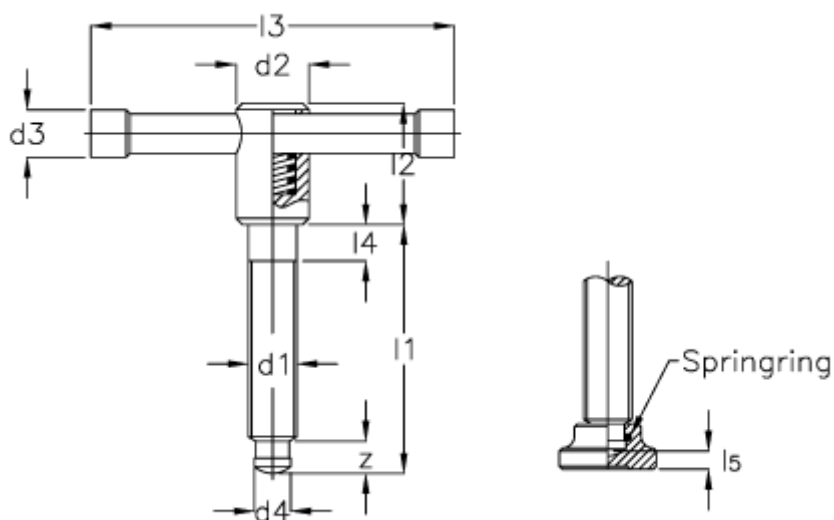

d1	= M 10	l5 = 3.6
d2	= 18	z = 8.2
d3	= 8	
d4 h11	= 8.0	
l1	= 50	
l2	= 32	
l3	= 80	
l4	= 10	